

THIS DOCUMENT IS SUBJECT TO CHANGE WITHOUT NOTICE. IT IS CONFIDENTIAL AND A PROPERTY OF Amphenol LTW. DISCLOSURE TO THIRD PARTY HAS TO BE AUTHORIZED BY Amphenol LTW.

REV.	ECN NO.	DATE	SIGN	DESCRIPTION
F	LEN1750030~41	2017/04/25	Lingpeng	Add 5Pin
G	LEN1790175~90	2017-08-29	Lingpeng	Update The Note
H	NI80019	2019-03-14	Peng	Add All Seals Product

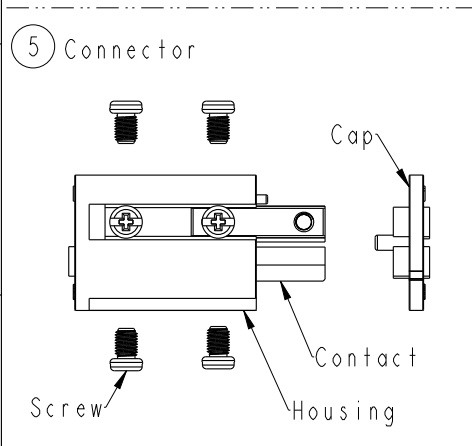

ALTW
CONFIDENTIAL
 2019-03-14
R&D DEPT.

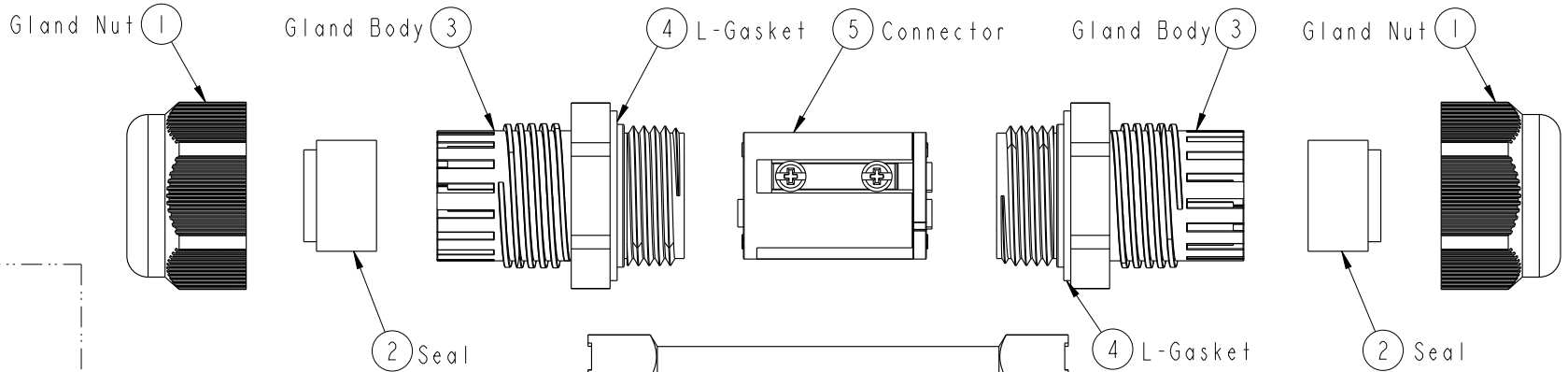
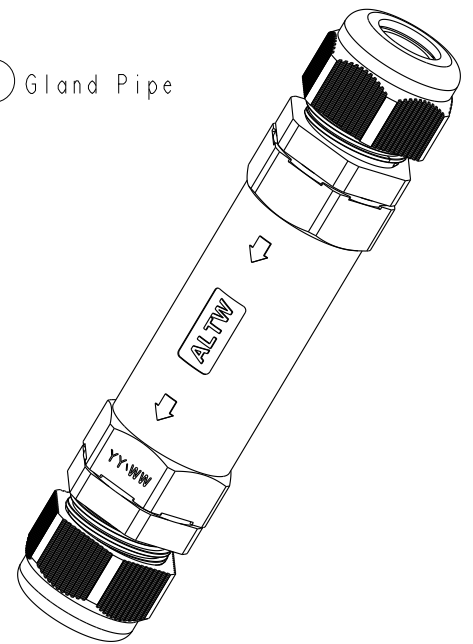
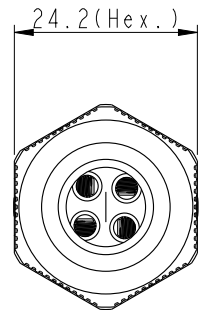
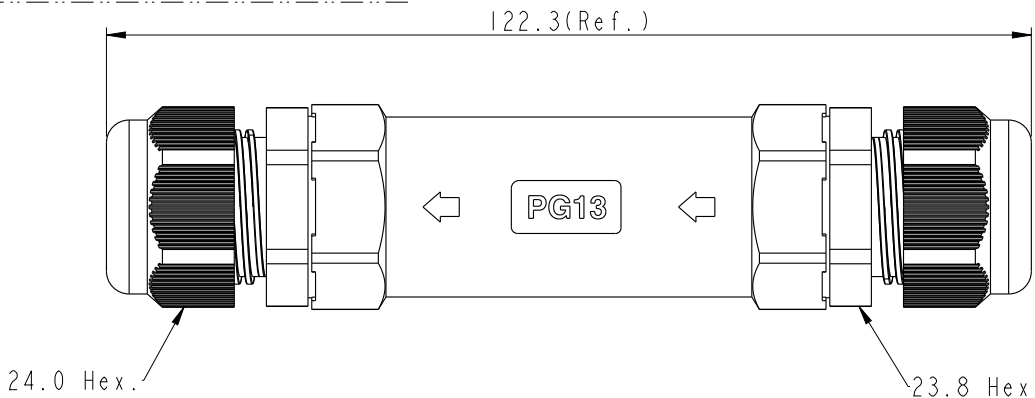
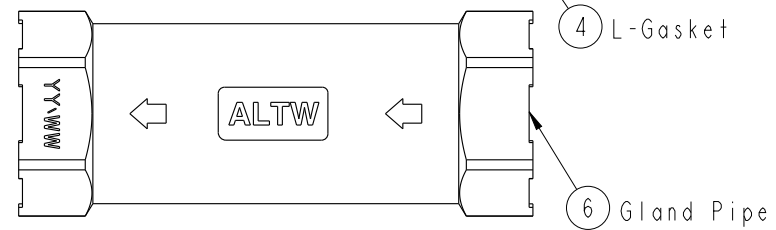

UNIT:mm	
TOLERANCE	±0.5mm

TITLE PG13 Cable Joiner Screw-in Type			
SCALE 1:1	SIZE A4	SHEET 1 OF 2	
REV. H	WC-REV. A.10	☉: Inspection item	

Amphenol LTW
 安費諾亮泰企業股份有限公司

ITEM NO.	DRAWN BY Peng	DATE 2019-03-14
DWG NO. SC-L-PG13-XX-XX	CHECKED BY Ma Fei	DATE 2019-03-14
CUSTOMER ALTW	APPROVED BY Jerry	DATE 2019-03-14

THIS DOCUMENT IS SUBJECT TO CHANGE WITHOUT NOTICE. IT IS CONFIDENTIAL AND A PROPERTY OF Amphenol LTW. DISCLOSURE TO THIRD PARTY HAS TO BE AUTHORIZED BY Amphenol LTW.

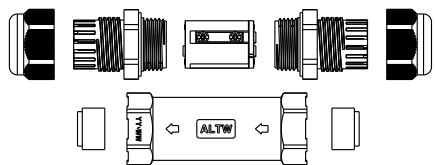

QTY: 1PCS

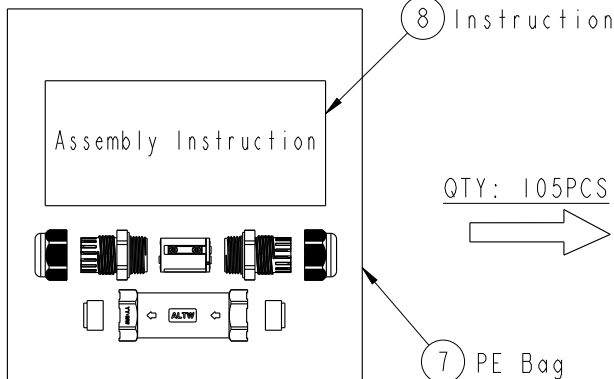
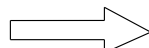

QTY: 105PCS

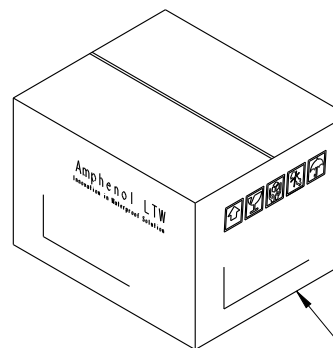
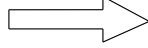

9 Carton

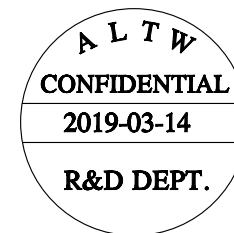

Both A Unassembled product And An Instruction Are In A PE Bag.
(將一套未組裝的產品和說明書，放置於一個PE袋，並封口)

SC-L-PG13-XX-XX
L: Cable Joiner
Type: PG13

Seal's Color: BL-Blue(藍色) For Cable Range: $\varnothing 4.5\sim\varnothing 6.5\text{mm}$
 YW-Yellow(黃色) For Cable Range: $\varnothing 6.5\sim\varnothing 8.5\text{mm}$
 GN-Green(綠色) For Cable Range: $\varnothing 8.5\sim\varnothing 10.5\text{mm}$
 RD-Red(紅色) For Cable Range: $\varnothing 10.5\sim\varnothing 11.5\text{mm}$
 AA-All Seals For Cable Range: $\varnothing 4.5\sim\varnothing 11.5\text{mm}$

No. of Conductor: 02-2Poles
 03-3Poles
 04-4Poles
 05-5Poles

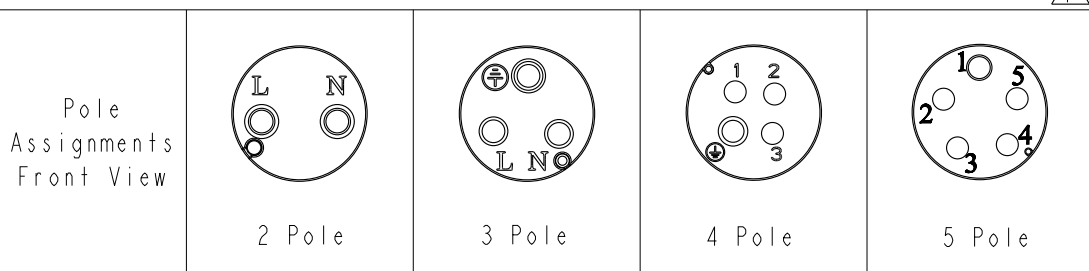

Note: $\triangle G$ $\triangle H$

- * QD Important Dimension To Check.
- * Waterproof Rate: IP68 (50M,24H)
- * Housing & Cap: PA66+GF, Black.
- * Gland Pipe: PA66, Black.
- * Gland Body: PA66, Black.
- * Gland Nut: PA6+GF, Black.
- * Contact: Brass, Nickel Plated
- * L-Gasket : Silicone, Yellow.
- * Seal: Silicone, Blue & Yellow & Green & Red.
- * Rated Voltage: 2~5 Pole 450V AC
- * Rated Current: 2 & 3 Pole Max. 20A ,
 4 Pole Max. 15A.
 5 Pole Max. 8A.
- * Operating Temperature: $-40^{\circ}\sim+105^{\circ}$.
- * Gland Pipe Recommended Tightening Torque:
 8~10 Kgf.cm(0.78~0.98 N.m)
- * Gland Nut Recommended Tightening Torque:
 8~10 Kgf.cm(0.78~0.98 N.m)
- * Seal For Cable OD: $\varnothing 4.5\sim\varnothing 6.5\text{mm}$, Blue.
 $\varnothing 6.5\sim\varnothing 8.5\text{mm}$, Yellow.
 $\varnothing 8.5\sim\varnothing 10.5\text{mm}$, Green .
 $\varnothing 10.5\sim\varnothing 11.5\text{mm}$, Red.
- * Screws for Wire connection recommended tightening torque: 2.00~4.50 kgf.cm / 0.196~0.44 N.m
- * Applicable Wire gauge (Stranded wire cross section) 0.75mm^2 (18AWG) ~ 2.5mm^2 (14AWG)

UNIT:mm		TITLE PG13 Cable Joiner Screw-in Type	
TOLERANCE	$\pm 0.5\text{mm}$ $\triangle H$	SCALE 1:1	SIZE A4
		REV. H	WC-REV. A.10
		SHEET 2 OF 2	
		QC: Inspection item	

Amphenol LTW
安費諾亮泰企業股份有限公司

ITEM NO	DRAWN BY Peng	DATE 2019-03-14
DWG NO SC-L-PG13-XX-XX	CHECKED BY Ma Fei	DATE 2019-03-14
CUSTOMER ALTW	APPROVED BY Jerry	DATE 2019-03-14