

Max. 280 m³/h

DC axial fans

□ 92 x 38 mm



- **Material:** Housing: GRP¹⁾ (PBT)
Impeller: GRP¹⁾ (PA)
 - **Direction of air flow:** Exhaust over struts
 - **Direction of rotation:** Clockwise, looking towards rotor
 - **Connection:** Via single wires AWG 24 (H3 and H4: AWG 22), TR 64
 - **Weight:** 240 g (H3 and H4: 280 g)
- **Possible special versions:** (See chapter DC fans - specials)
 - Speed signal
 - Go / NoGo alarm
 - Alarm with speed limit
 - External temperature sensor
 - Internal temperature sensor
 - PWM control input
 - Analog control input
 - Moisture protection
 - Degree of protection: IP 54 / IP 68

1) Fiberglass-reinforced plastic

Series 3200 J

Nominal data

Type	Air flow		Nominal voltage	Voltage range	Sound pressure level	Sound power level	Sinter sleeve bearings Ball bearings	Power consumption*	Nominal speed	Temperature range	Service life L ₁₀ (40 °C) ebm-papst standard	Service life L ₁₀ (T _{max}) ebm-papst standard	Life expectancy L ₁₀ IPC (40 °C) see page 17	Curve
	m ³ /h	cfm												
3212 JN	130	76.5	12	7...13.8	51	6.1	■	7.5	6 000	-20 ...+70	70 000 / 35 000	117 500	①	
3212 JH	146	86.0	12	7...15	55	6.4	■	9.0	6 800	-20 ...+70	70 000 / 35 000	117 500	②	
3212 JH3 <i>S-Force</i>	237	139.5	12	6...13.8	69	7.8	■	31.0*	11 000	-20 ...+70	65 000 / 32 500	110 000	③	
3212 JH4 <i>S-Force</i>	280	164.8	12	6...13.8	73	8.2	■	50.0*	13 000	-20 ...+70	60 000 / 30 000	110 000	④	
3214 JN	130	76.5	24	11...28	51	6.1	■	6.5	6 000	-20 ...+70	70 000 / 35 000	117 500	①	
3214 JH	146	86.0	24	12...30	55	6.4	■	9.0	6 800	-20 ...+70	70 000 / 35 000	117 500	②	
3214 JH3 <i>S-Force</i>	237	139.5	24	12...27.6	69	7.8	■	30.0*	11 000	-20 ...+70	65 000 / 32 500	110 000	③	
3214 JH4 <i>S-Force</i>	280	164.8	24	12...27.6	73	8.2	■	50.0*	13 000	-20 ...+70	60 000 / 30 000	110 000	④	
3218 JN	130	76.5	48	36...56	51	6.1	■	7.0	6 000	-20 ...+70	70 000 / 35 000	117 500	①	
3218 JH	146	86.0	48	36...53	55	6.4	■	9.5	6 800	-20 ...+70	70 000 / 35 000	117 500	②	
3218 JH3 <i>S-Force</i>	237	139.5	48	20...58.0	69	7.8	■	29.0*	11 000	-20 ...+70	65 000 / 32 500	110 000	③	
3218 JH4 <i>S-Force</i>	280	164.8	48	20...58.0	73	8.2	■	50.0*	13 000	-20 ...+70	60 000 / 30 000	110 000	④	

Subject to change

3200 JH3 and JH4 also available as standard with PWM control input and speed signal.

Speed control range from 2000 rpm⁻¹ up to maximum nominal speed. Standstill at 0% PWM, maximum speed if control cable is interrupted.

* Power consumption at free air flow. These values can be significantly higher in the operating point.

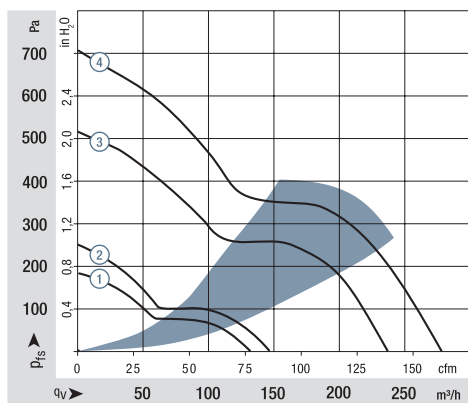

Air performance measured according to: ISO 5801.
Installation category A, without contact protection.
Noise: Total sound power level L_{WA} ISO 103002 measured on a hemisphere with a radius of 2 m.
Sound pressure level L_{pA} measured at 1 m distance from fan axis.
The values given are applicable only under the specified measuring conditions and may differ depending on the installation conditions.
In the event of deviation from the standard configuration, the parameters must be checked after installation!
For detailed information see <http://www.ebmpapst.com/general-conditions>

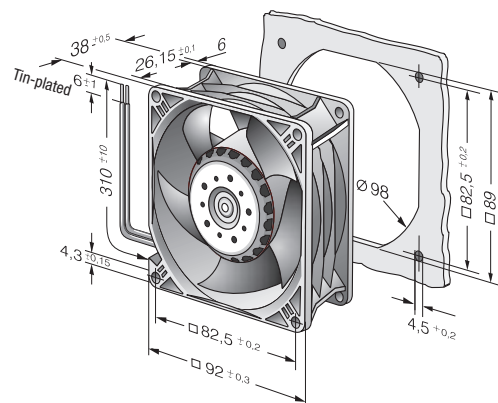

Speed signal /2

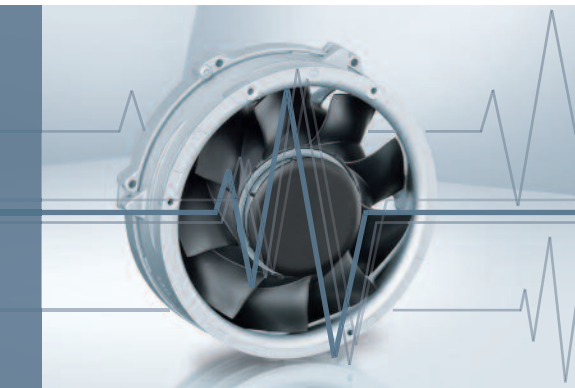

- Speed-proportional, square-wave signal for external monitoring of the fan motor speed
- 2, 3, or 6 pulses per revolution
- Open-collector signal output
- Extremely wide operating voltage range
- Easy adaptation to user interface
- Connection via separate cable
- The sensor signal also serves as a major comparison variable for setting and maintaining the setpoint speed for interactive or controlled cooling with one or more interconnected fans.

Electrical hookup

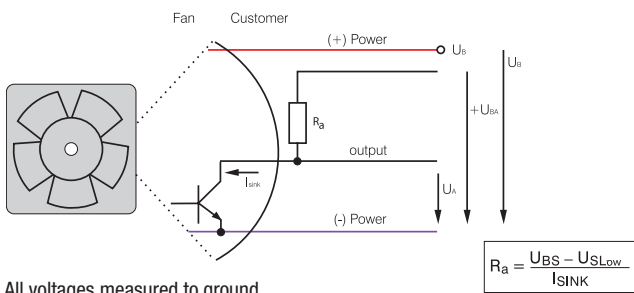

All voltages measured to ground.
External load resistor R_a / U_S / U_{BS} required.

Signal output voltage

Standard signal for all models (exceptions see below)

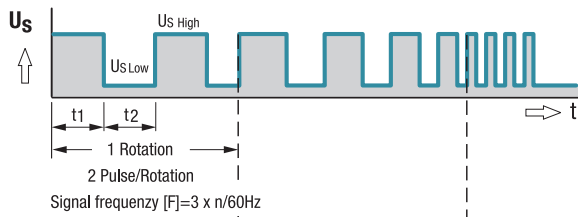

For multi options control input and 4100 NH7 and NH8

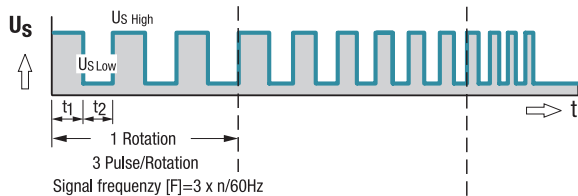

All TD Fans e.g. 6300 TD

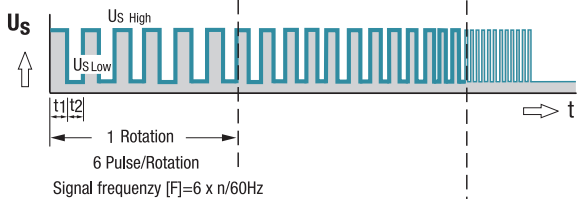

Fan speed

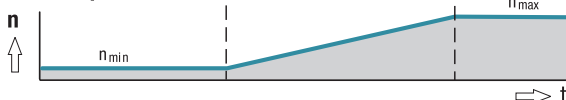

Signal data	Speed signal	Condition:	Speed signal	Condition:	Tach operating	Admissible sink current	Pulses per revolution	Fan description
	$U_{S\ Low}$	I_{sink}	$U_{S\ High}$	I_{source}	voltage $U_{BS\ max.}$	$I_{sink\ max.}$		Basic type
Type	VDC	mA	VDC	mA	VDC	mA	Page	
250	≤ 0.4	2	≤ 30	0	30	2	2	31
400 F	≤ 0.4	1	≤ 30	0	30	2	2	32
400	≤ 0.4	1	≤ 30	0	30	2	2	33
420 J	≤ 0.4	2	≤ 15	0	15	4	2	34
500 F	≤ 0.4	1	≤ 30	0	30	2	2	35
600 F	≤ 0.4	1	≤ 30	0	30	2	2	36
620	≤ 0.4	2	≤ 30	0	30	4	2	37
630 U	≤ 0.4	2	≤ 30	0	30	4	2	38
600 N	≤ 0.4	2	≤ 28	0	28	4	2	39
600 J	≤ 0.4	2	≤ 30	0	30	4	2	41
700 F	≤ 0.4	2	≤ 30	0	30	4	2	42
8450	≤ 0.4	2	≤ 28	0	28	4	2	43
8400 N	≤ 0.4	2	≤ 28	0	28	4	2	44
8400 N VARIOFAN	≤ 0.4	2	≤ 30	0	30	4	2	45
8300	≤ 0.4	2	≤ 30	0	30	4	2	46
8200 J	≤ 0.4	2	≤ 30	0	30	4	2	47
3400 N	≤ 0.4	2	≤ 28	0	28	4	2	48
3400 N VARIOFAN	≤ 0.4	2	≤ 30	0	30	4	2	49
3300 N	≤ 0.4	2	≤ 30	0	30	4	2	50
3212 J / 3214 J	≤ 0.4	2	≤ 30	0	30	4	2	51
3218 J	≤ 0.4	2	≤ 60	0	60	4	2	51
3250 J	≤ 0.4	2	≤ 60	0	60	4	3	52
4412 F / 4414 F	≤ 0.4	2	≤ 30	0	30	4	2	53
4418 F	≤ 0.4	2	≤ 60	0	60	4	2	53
4400 FN	≤ 0.4	2	≤ 30	0	30	4	2	55
4312 / 4314	≤ 0.4	2	≤ 30	0	30	4	2	56
4318	≤ 0.4	2	≤ 60	0	60	4	2	56
4312 / 4314 VARIOFAN	≤ 0.4	2	≤ 30	0	30	4	2	57
4318 VARIOFAN	≤ 0.4	2	≤ 60	0	60	4	2	57
4400	≤ 0.4	2	≤ 30	0	30	4	2	58/59
4100 N	≤ 0.4	2	≤ 30	0	30	4	2	60
4100 NHH...NH6	≤ 0.4	2	≤ 60	0	60	10	2	61
4100 NH7...NH8	≤ 0.4	2	≤ 60	0	60	20	3	62
DV 4100	≤ 0.4	2	≤ 30	0	30	4	2	63
5200 N	≤ 0.4	2	≤ 30	0	30	4	2	64
DV 5200	≤ 0.4	2	≤ 30	0	30	4	2	65

Subject to change

Available on request:

- Electrically isolated speed signal circuit
- Varying voltage potentials for power and logic circuit

Signal data		Speed signal $U_{S\text{ Low}}$	Condition: I_{sink}	Speed signal $U_{S\text{ High}}$	Condition: I_{source}	Tach operating voltage $U_{BS\text{ max}}$	Admissible sink current $I_{\text{sink max}}$	Pulses per revolution	Fan description Basic type
Type	VDC	mA	VDC	mA	VDC	mA		Page	
5112 N	≤ 0.4	2	≤ 15	0	5	20	2	66	
5114 N / 5118 N	≤ 0.4	2	≤ 60	0	60	20	2	66	
5300	≤ 0.4	2	≤ 60	0	60	4	2	67	
5300 TD	≤ 0.4	2	≤ 60	0	60	20	6	68	
7112 N / 7118 N	≤ 0.4	2	≤ 60	0	60	20	2	69	
7114 N	≤ 0.4	2	≤ 30	0	30	20	2	69	
7200 N	≤ 0.4	2	≤ 15	0	15	20	2	70	
6400	≤ 0.4	2	≤ 60	0	60	20	2	71	
6300 TD	≤ 0.4	2	≤ 60	0	60	20	6	75	
6300 N	≤ 0.4	2	≤ 60	0	60	20	6	76	
6300 NTD	≤ 0.4	2	≤ 60	0	60	20	6	77	
6300	≤ 0.4	2	≤ 60	0	60	20	2	78	
DV 6300 TD	≤ 0.4	2	≤ 60	0	60	20	6	80	
2200 FTD	≤ 0.4	2	≤ 60	0	60	20	6	81	
RL 48	≤ 0.4	2	≤ 30	0	30	4	2	97	
RL 65	≤ 0.4	2	≤ 30	0	30	4	2	98	
RL 90 N	≤ 0.4	2	≤ 30	0	30	4	2	99	
RLF 100	≤ 0.4	2	≤ 30	0	30	4	2	100	
RG 90 N	≤ 0.4	2	≤ 30	0	30	4	2	101	
RG 125 N	≤ 0.4	2	≤ 30	0	30	4	2	102	
RG 140 N	≤ 0.4	3	≤ 60	0	60	4	2	103	
RG 160 N	≤ 0.4	2	≤ 30	0	30	20	2	104	
RG 160 NTD	≤ 0.4	2	≤ 60	0	60	20	6	105	
RG 190 TD	≤ 0.4	2	≤ 60	0	60	20	6	106	
RG 220 TD	≤ 0.4	2	≤ 60	0	60	20	6	107	
RG 225 TD	≤ 0.4	2	≤ 60	0	60	20	6	108	
RET 97 TD	≤ 0.4	2	≤ 60	0	60	20	6	109	
REF 100	≤ 0.4	2	≤ 30	0	30	4	2	110	
RER 120 TD	≤ 0.4	2	≤ 60	0	60	20	6	112	
RER 133 TD	≤ 0.4	2	≤ 60	0	60	20	6	117	
RER 160 NTD	≤ 0.4	2	≤ 60	0	60	20	6	119	
REF 175 TD	≤ 0.4	2	≤ 60	0	60	20	6	120	
RER 175 TD	≤ 0.4	2	≤ 60	0	60	20	6	121	
RER 190 TD	≤ 0.4	2	≤ 60	0	60	20	6	122	
RER 220 TD	≤ 0.4	2	≤ 60	0	60	20	6	128	
RER 225 TD	≤ 0.4	2	≤ 60	0	60	20	6	129	

Subject to change

Note:

Fans that come with these fan specials could have variations with respect to the temperature range, voltage range, and power consumption compared to standard fans without specials.