

EMC/EMI Filter for PV Inverters



- Reduces conducted emissions towards the solar panel
- Reduces the probability of EMI radiation off the solar panel
- Helps to prevent pre-mature panel aging because of HF leakage currents
- Helps to meet international EMC regulations for the entire PV system
- Most compact standard solution in the industry, optionally available without capacitors to ground (B types)
- New: up to 2300 A



Performance indicators

Attenuation performance



Rated current [A]



Technical specifications

Maximum continuous operating voltage	Max. 1200 VDC
Operating frequency	DC
Rated currents	25 to 2300 A @ 55°C
High potential test voltage	P → E 3600 VDC for 2 sec P → P 3000 VDC for 2 sec
Protection category	IP 20 (25 to 150 A types); IP 00 (250 to 2300 A types)
Overload capability	4x rated current at switch on, 1.5x rated current for 1 minute, once per hour
Temperature range (operation and storage)	-40°C to +100°C (40/100/21)
Design corresponding to	UL 1283, CSA 22.2 No. 8 1986, IEC/EN 60939
Flammability corresponding to	UL 94 V-2 or better
MTBF @ 55°C/1200 V (Mil-HB-217F)	min. 223,000 hours

Approvals & Compliances



(cURus:600 VDC) (ENEC 14: 600 VDC)

FN2200 are very compact DC filters for PV inverters and therefore support the integration in shrinking frame sizes of power electronics. All FN2200 come in unsymmetrical housings, which help to prevent inverse installation and wrong electrical connection. Along with grid-side installed AC EMC/EMI filters, FN2200 are key to meet the international EMC standards like EN 61000-6-3 and -6-4 and help to ensure reliable operation of the system. FN2200 are designed for very low power loss, to support overall efficiency.

Features and benefits

Installed between the PV inverter and the solar panel, FN2200 DC filters help to control conducted emissions on the panel side of the system and therefore reduce the potential for interference radiation off the panel. The filter also protects the solar panel from HF stray and leakage currents which can cause pre-mature aging in the PV modules.

Typical applications

FN 2200 are primarily designed for PV inverters. However, they can potentially also be used in other DC applications within published specifications, like UPS, DC motor drives, or DC quick chargers.



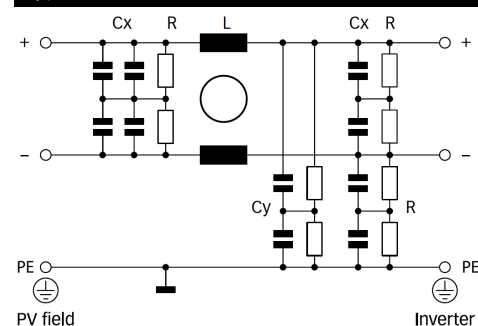



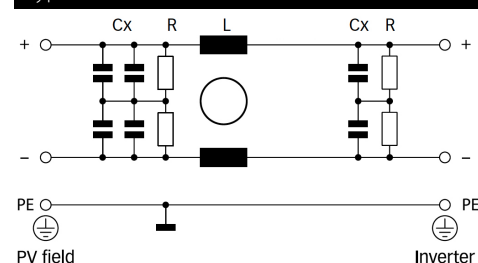



















Typical electrical schematic FN2200



Typical electrical schematic FN2200B



Filter selection table

Filter	Buy	Rated current	Typical inverter	Filter efficiency	Power loss	Input/Output connections		Weight
		@ 55°C (40°C)	AC power rating*	@ 25°C/DC	@ 25°C/DC			[kg]
		[A]	[kW]	[%]	[W]			
FN2200-25-33		25 (28)	10	> 99.9	8	-33		0.9
FN2200-50-34		50 (57)	20	> 99.9	17	-34		1.6
FN2200-75-34		75 (86)	30	> 99.9	18	-34		1.7
FN2200-100-35		100 (115)	40	> 99.9	22	-35		2.7
FN2200-150-40		150 (173)	60	> 99.9	31	-40		4.9
FN2200-250-99		250 (288)	100	> 99.9	10		-99	5.0
FN2200-400-99		400 (460)	150	> 99.9	16		-99	6.1
FN2200-600-99		600 (690)	250	> 99.9	29		-99	6.5
FN2200-800-99		800 (920)	350	> 99.9	26		-99	9.3
FN2200-1000-99		1000 (1150)	400	> 99.9	40		-99	9.4
FN2200-1500-99		1500 (1600)	500	> 99.9	45		-99	14.6
FN2200-2300-99		2300 (2500)	800/1000	> 99.9	84		-99	25.0
FN2200B-25-33		25 (28)	10	> 99.9	8	-33		0.9
FN2200B-50-34		50 (57)	20	> 99.9	17	-34		1.6
FN2200B-75-34		75 (86)	30	> 99.9	18	-34		1.7
FN2200B-100-35		100 (115)	40	> 99.9	22	-35		2.7
FN2200B-150-40		150 (173)	60	> 99.9	31	-40		4.9
FN2200B-250-99		250 (288)	100	> 99.9	10		-99	5.0
FN2200B-400-99		400 (460)	150	> 99.9	16		-99	6.1
FN2200B-600-99		600 (690)	250	> 99.9	29		-99	6.5
FN2200B-800-99		800 (920)	350	> 99.9	26		-99	9.3
FN2200B-1000-99		1000 (1150)	400	> 99.9	40		-99	9.4
FN2200B-1500-99		1500 (1600)	500	> 99.9	45		-99	14.6
FN2200B-2300-99		2300 (2500)	800/1000	> 99.9	84		-99	25.0

* Based on rated DC current of typical 3-phase PV inverters with 900 VDC input. Note: depending upon manufacturer and model, DC currents for a given PV inverter power can differ significantly. Filters with higher current ratings for large central inverters up to the MW range are available upon request.

Distribution inventory

Up-to-date inventory levels for global distributors is available at

<https://products.schaffner.com/stock>



Typical filter attenuation

Per CISPR 17; A=50 Ω/50 Ω sym; B=50 Ω/50 Ω asym; C=0.1 Ω/100 Ω sym; D=100 Ω/0.1 Ω sym

25 to 75 A types

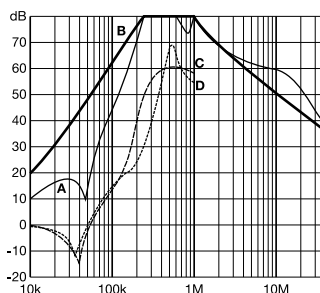

100 to 150 A types

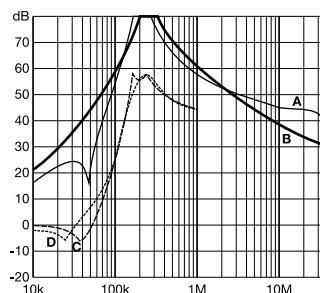

250 A types

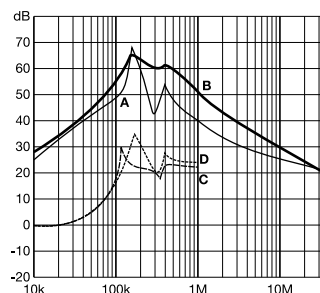

400 to 2300 A types

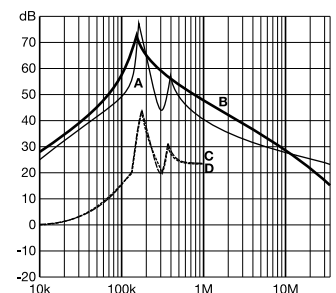

Typical block schematic

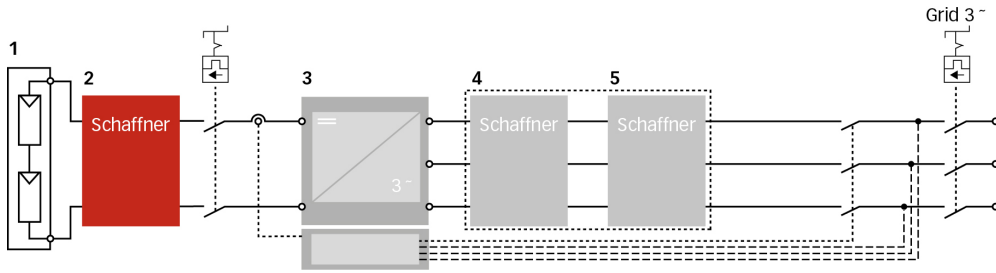

1 PV modules
2 Schaffner FN 2200

3 Central Inverter
4 Schaffner magnetic components

5 Schaffner AC EMC/EMI filter

Mechanical data

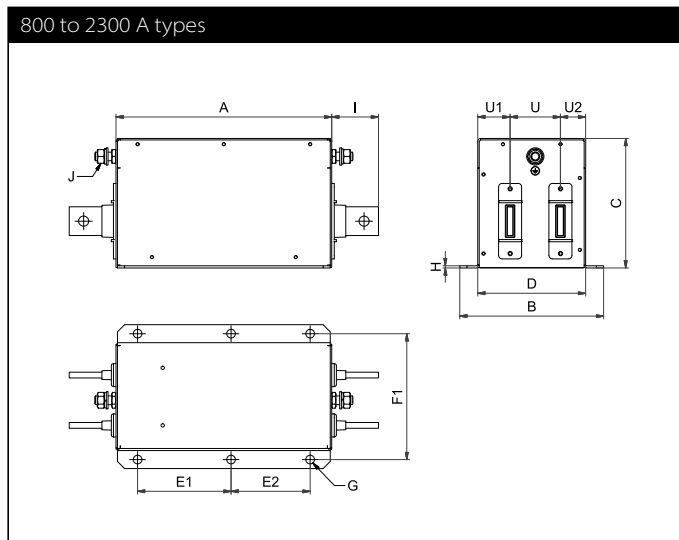
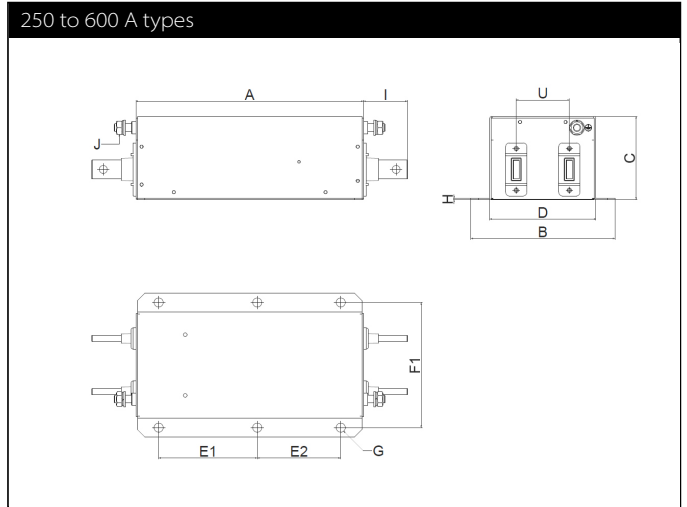
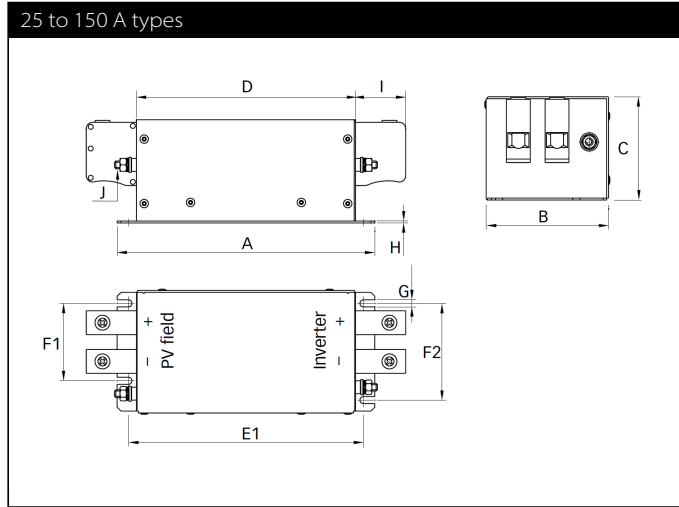

Note: all FN 2200 provide unsymmetrical mounting hole patterns to prevent inverse filter installation in the field. (Dimensions E1 E2 and F1/F2)

Busbar connections

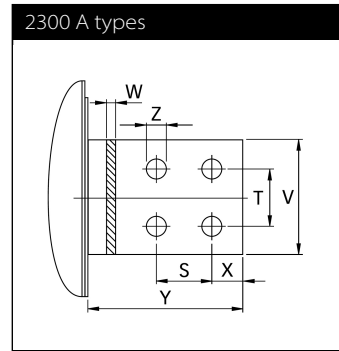
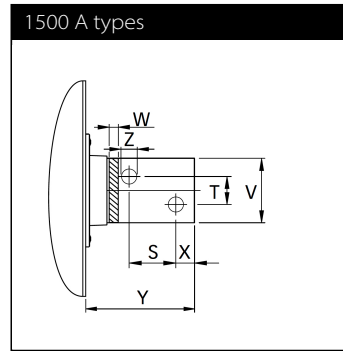
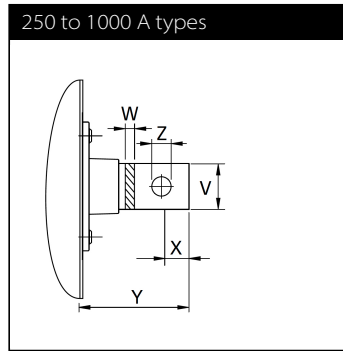

Dimensions

	25 A	50 A	75 A	100 A	150 A	250 A	400 A	600 A	800 A	1000 A	1500 A	2300 A
A	170	200	200	220	250	300	300	300	300	300	300	400
B	80	95	95	125	140	180	190	190	200	200	200	250
C	65	80	80	95	115	110	110	110	140	140	150	180
D	140	170	170	190	220	130	140	140	150	150	150	195
E1	152.5	182.5	182.5	202.5	232.5	130	130	130	130	130	130	190
E2						110	110	110	110	110	110	150
F1	45	60	60	80	100	155	165	165	175	175	175	225
F2	60	75	75	100	120							
G	5.5	5.5	5.5	5.5	5.5	Ø 12	Ø 12	Ø 12	Ø 12	Ø 12	Ø 12	Ø 12
H	1	1.5	1.5	1.5	2	2	2	2	3	3	3	3
I	25	39	39	45	51	58	58	58	65	65	110	100
J	M5	M6	M6	M8	M10	M10	M10	M10	M12	M12	M12	M16
S											43	35
T											26	35
U						70	70	70	70	70	70	100
U1									45	45	55	61
U2									35	35	25	34
V						20	25	25	40	40	60	70
W						5	6	8	8	8	10	15
X						15	15	15	20	20	17	20
Y						58	58	58	65	65	110	100
Z						Ø 9	Ø 10.5	Ø 10.5	Ø 14	Ø 14	Ø 14	Ø 14

All dimensions in mm; 1 inch = 25.4 mm
Tolerances according to: ISO 2768-m/EN 22768-m

Filter input/output connector cross sections

	-33	-34	-35	-40
Solid wire	16 mm ²	35 mm ²	50 mm ²	95 mm ²
Flex wire	10 mm ²	25 mm ²	50 mm ²	95 mm ²
AWG type wire	AWG 6	AWG 2	AWG 1/0	AWG 4/0
Recommended torque	1.5-1.8 NM	4.0-4.5 NM	7-8 NM	17-20 NM

Please visit www.schaffner.com to find more details on filter connectors.



Headquarters, global innovation and development

Switzerland

Schaffner Group

Industrie Nord
Nordstrasse 11e
4542 Luterbach
T +41 32 681 66 26
info@schaffner.com



Sales and application centers

China

Schaffner EMC Ltd. Shanghai

T20-3 C, No 565 Chuangye Road,
Pudong district
201201 Shanghai
T +86 21 3813 9500
cschina@schaffner.com
www.schaffner.com.cn

Finland

Schaffner Oy

Sauvonrinne 19 H
08500 Lohja
T +358 50 468 7284
finlandsales@schaffner.com

France

Schaffner EMC S.A.S.

16-20 Rue Louis Rameau
95875 Bezons
T +33 1 34 34 30 60
F +33 1 39 47 02 28
francesales@schaffner.com

Germany

Schaffner Deutschland GmbH

Schoemperlenstrasse 12B
76185 Karlsruhe
T +49 721 56910
germanysales@schaffner.com

India

Schaffner India Pvt. Ltd

REGUS WORLD TRADE CENTRE
WTC, 22nd Floor Unit No 2238, Brigade
Gateway Campus, 26/1, Dr. Rajkumar Road
Malleshwaram (W)
560055 Bangalore
T +91 80 67935355
indiasales@schaffner.com

Italy

Schaffner EMC S.r.l.

Via Ticino, 30
20900 Monza (MB)
T +39 039 21 41 070
italysales@schaffner.com

Japan

Schaffner EMC K.K.

Taiju-Seimei Sangenjaya Bldg.
1-32-12, Kamiyuma, Setagaya-ku
154-0011 Tokyo
T +81 3 5712 3650
F +81 3 5712 3651
japansales@schaffner.com
www.schaffner.jp

Singapore

Schaffner EMC Pte Ltd.

#05-09, Kg Ubi Ind. Estate
408705 Singapore
T +65 6377 3283
F +65 6377 3281
singaporesales@schaffner.com

Spain

Schaffner EMC España

Calle Caléndula 93, Miniparc III, Edificio E
El Soto de Moraleja, Alcobendas
28109 Madrid
T +34 917 912 900
F +34 917 912 901
spainsales@schaffner.com

Sweden

Schaffner EMC AB

Östermalmstorg 1
114 42 Stockholm
T +46 8 5050 2425
swedensales@schaffner.com
www.schaffner.com

Switzerland

Schaffner EMV AG

Industrie Nord
Nordstrasse 11e
4542 Luterbach
T +41 32 681 66 88
T +41 32 681 66 26
switzerlandsales@schaffner.com

Taiwan

Schaffner EMV Ltd.

20 Floor-2, No 97, Section 1, XinTai 5th Road
22175 XiZhi District New Taipei City 22175
T +886 2 2697 5500
F +886 2 2697 5533
taiwansales@schaffner.com
www.schaffner.com.tw

Thailand

Schaffner EMC Co. Ltd.

Northern Region Industrial Estate
67 Moo 4 Tambon Ban Klang
Amphur Muangng P.O. Box 14
51000 Lamphun
T +66 53 58 11 04
F +66 53 58 10 19
thailandsales@schaffner.com

United Kingdom

Schaffner Ltd.

1, Oakmede Place
Binfield
RG42 4JF Berkshire
T +44 118 9770070
F +44 118 9792969
uksales@schaffner.com

USA

Schaffner EMC Inc.

52 Mayfield Avenue
Edison, New Jersey
T +1 732 225 9533
F +1 732 225 4789
usasales@schaffner.com
www.schaffnerusa.com

To find your local partner within Schaffner's global network: www.schaffner.com

© 2022 Schaffner Group

The content of this document has been carefully checked and understood. However, neither Schaffner nor its subsidiaries assume any liability whatsoever for any errors or inaccuracies of this document and the consequences thereof. Published specifications are subject to change without notice. Product suitability for any area of application must ultimately be determined by the customer. In all cases, products must never be operated outside their published specifications. Schaffner does not guarantee the availability of all published products. This disclaimer shall be governed by substantive Swiss law and resulting disputes shall be settled by the courts at the place of business of Schaffner Holding AG. Latest publications and a complete disclaimer can be downloaded from the Schaffner website. All trademarks recognized.