

## LSF-SMT 7.50/02/135 3.5SN BK TU

**Weidmüller Interface GmbH & Co. KG**  
Klingenbergstraße 26  
D-32758 Detmold  
Germany

www.weidmueller.com

### Product image

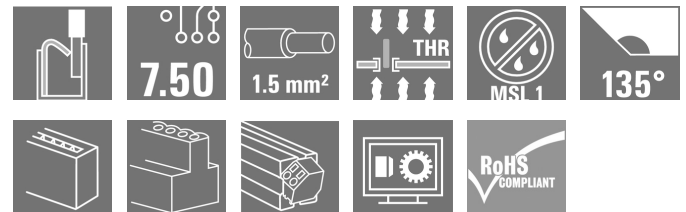

Similar to illustration

PCB terminal for fully automatic assembly in reflow soldering (SMT), with Push In conductor connection system. Conductor inserted and slider operated in same direction (TOP). Packed in box or as tape on reel. Pin lengths optimised at 1.5 mm or 3.5 mm.

### General ordering data

Version	Printed circuit board terminals, 7.50 mm, Number of poles: 2, 135°, Solder pin length (l): 3.5 mm, black, PUSH IN with actuator, Clamping range, max.: 1.5 mm <sup>2</sup> , Tube
Order No.	<a href="#">1886110000</a>
Type	LSF-SMT 7.50/02/135 3.5SN BK TU
GTIN (EAN)	4032248491032
Qty.	47 pc(s).
Product data	IEC: 800 V / 17.5 A / 0.2 - 1.5 mm <sup>2</sup> UL: 300 V / 12 A / AWG 28 - AWG 14
Packaging	Tube

Creation date December 4, 2023 11:46:28 AM CET

## LSF-SMT 7.50/02/135 3.5SN BK TU

Weidmüller Interface GmbH &amp; Co. KG

Klingenbergstraße 26

D-32758 Detmold

Germany

www.weidmueller.com

## Technical data

## Dimensions and weights

Depth	12.7 mm	Depth (inches)	0.5 inch
Height	16.4 mm	Height (inches)	0.646 inch
Height of lowest version	12.9 mm	Width	11.7 mm
Width (inches)	0.461 inch	Net weight	2.51 g

## Temperatures

Continuous operating temp., max.	120 °C
----------------------------------	--------

## System parameters

Product family	OMNIMATE Signal - series LSF	Wire connection method	PUSH IN with actuator
Mounting onto the PCB	THT/THR solder connection	Conductor outlet direction	135°
Pitch in mm (P)	7.5 mm	Pitch in inches (P)	0.295 inch
Number of poles	2	Pin series quantity	1
Fitted by customer	No	Number of rows	1
Solder pin length (l)	3.5 mm	Solder pin length tolerance	+0.1 / -0.3 mm
Solder pin dimensions	0.35 x 0.8 mm	Solder pin dimensions = d tolerance	0 / -0.1 mm
Solder eyelet hole diameter (D)	1.1 mm	Solder eyelet hole diameter tolerance (D)	+ 0,1 mm
Number of solder pins per pole	2	Stripping length	8 mm
L1 in mm	7.5 mm	L1 in inches	0.295 inch
Touch-safe protection acc. to DIN VDE 0470	IP 20	Touch-safe protection acc. to DIN VDE 57 106	Safe from finger touch
Protection degree	IP20	Volume resistance	1.60 mΩ

## Material data

Insulating material	LCP GF	Colour	black
Colour chart (similar)	RAL 9011	Insulating material group	IIIa
Comparative Tracking Index (CTI)	≥ 175	Moisture Level (MSL)	1
UL 94 flammability rating	V-0	Contact material	Cu-alloy
Layer structure of solder connection	4...6 µm Sn matt	Storage temperature, min.	-40 °C
Storage temperature, max.	70 °C	Operating temperature, min.	-50 °C
Operating temperature, max.	120 °C	Temperature range, installation, min.	-30 °C
Temperature range, installation, max.	120 °C		

## Conductors suitable for connection

Clamping range, min.	0.13 mm <sup>2</sup>
Clamping range, max.	1.5 mm <sup>2</sup>
Wire connection cross section AWG, min.	AWG 28
Wire connection cross section AWG, max.	AWG 14
Solid, min. H05(07) V-U	0.2 mm <sup>2</sup>
Solid, max. H05(07) V-U	1.5 mm <sup>2</sup>
Flexible, min. H05(07) V-K	0.2 mm <sup>2</sup>
Flexible, max. H05(07) V-K	1.5 mm <sup>2</sup>
w. plastic collar ferrule, DIN 46228 pt 4, min.	0.25 mm <sup>2</sup>
w. plastic collar ferrule, DIN 46228 pt 4, max.	0.75 mm <sup>2</sup>
w. wire end ferrule, DIN 46228 pt 1, min.	0.25 mm <sup>2</sup>

Creation date December 4, 2023 11:46:28 AM CET

Catalogue status 24.11.2023 / We reserve the right to make technical changes.

2

**LSF-SMT 7.50/02/135 3.5SN BK TU**
**Weidmüller Interface GmbH & Co. KG**

Klingenbergstraße 26

D-32758 Detmold

Germany

www.weidmueller.com

**Technical data**

w. wire end ferrule, DIN 46228 pt 1, max. 1.5 mm<sup>2</sup>

Clampable conductor	Cross-section for conductor connection	Type	fine-wired
		nominal	0.25 mm <sup>2</sup>
wire end ferrule		Stripping length	nominal 10 mm
		Recommended wire-end ferrule	<a href="#">HO.25/12 HBL</a>
Clampable conductor	Cross-section for conductor connection	Type	fine-wired
		nominal	0.34 mm <sup>2</sup>
wire end ferrule		Stripping length	nominal 10 mm
		Recommended wire-end ferrule	<a href="#">HO.34/12 TK</a>
Clampable conductor	Cross-section for conductor connection	Type	fine-wired
		nominal	0.5 mm <sup>2</sup>
wire end ferrule		Stripping length	nominal 10 mm
		Recommended wire-end ferrule	<a href="#">HO.5/14 OR</a>
Clampable conductor	Cross-section for conductor connection	Type	fine-wired
		nominal	0.75 mm <sup>2</sup>
wire end ferrule		Stripping length	nominal 10 mm
		Recommended wire-end ferrule	<a href="#">HO.75/14T HBL</a>

Reference text Length of ferrules is to be chosen depending on the product and the rated voltage.. The outside diameter of the plastic collar should not be larger than the pitch (P)

**Rated data acc. to IEC**

tested acc. to standard	IEC 60664-1, IEC 61984	Rated current, min. number of poles (Tu=20°C)	17.5 A
Rated current, max. number of poles (Tu=20°C)	17.5 A	Rated current, min. number of poles (Tu=40°C)	17.5 A
Rated current, max. number of poles (Tu=40°C)	15 A	Rated voltage for surge voltage class / pollution degree II/2	800 V
Rated voltage for surge voltage class / pollution degree III/2	630 V	Rated voltage for surge voltage class / pollution degree III/3	500 V
Rated impulse voltage for surge voltage class/ pollution degree II/2	6 kV	Rated impulse voltage for surge voltage class/ pollution degree III/2	6 kV
Rated impulse voltage for surge voltage class/ contamination degree III/3	6 kV	Short-time withstand current resistance	3 x 1s with 80 A

**Rated data acc. to CSA**

Institute (CSA)		Certificate No. (CSA)	200039-1664286
Rated voltage (Use group B / CSA)	300 V	Rated voltage (Use group D / CSA)	300 V
Rated current (Use group B / CSA)	10 A	Rated current (Use group D / CSA)	10 A
Wire cross-section, AWG, min.	AWG 28	Wire cross-section, AWG, max.	AWG 14
Reference to approval values	Specifications are maximum values, details - see approval certificate.		

**LSF-SMT 7.50/02/135 3.5SN BK TU**

**Weidmüller Interface GmbH & Co. KG**  
 Klingenbergstraße 26  
 D-32758 Detmold  
 Germany

www.weidmueller.com

**Technical data**

**Rated data acc. to UL 1059**

Institute (cURus)



Certificate No. (cURus)

E60693

Rated voltage (Use group B / UL 1059)	300 V	Rated voltage (Use group D / UL 1059)	300 V
Rated current (Use group B / UL 1059)	12 A	Rated current (Use group D / UL 1059)	10 A
Wire cross-section, AWG, min.	AWG 28	Wire cross-section, AWG, max.	AWG 14
Reference to approval values	Specifications are maximum values, details - see approval certificate.		

**Packing**

Packaging	Tube	VPE length	555 mm
VPE width	20 mm	VPE height	10 mm
Surface resistance	Rs = 10 <sup>9</sup> - 10 <sup>12</sup> Ω		

**Type tests**

Test: Durability of markings	Test	mark of origin, type identification, pitch, approval marking UL, durability	
	Evaluation	available	
Test: Clampable cross section	Standard	DIN EN 60999-1 section 7 and 9.1 / 12.00, DIN EN 60947-1 section 8.2.4.5.1 / 12.02	
	Conductor type	Type of conductor and conductor cross-section	solid 0.14 mm <sup>2</sup>
		Type of conductor and conductor cross-section	stranded 0.14 mm <sup>2</sup>
		Type of conductor and conductor cross-section	solid 1.5 mm <sup>2</sup>
		Type of conductor and conductor cross-section	stranded 1.5 mm <sup>2</sup>
		Type of conductor and conductor cross-section	AWG 24/1
		Type of conductor and conductor cross-section	AWG 24/19
		Type of conductor and conductor cross-section	AWG 16/1
		Type of conductor and conductor cross-section	AWG 16/19
Evaluation	passed		

**LSF-SMT 7.50/02/135 3.5SN BK TU**

**Weidmüller Interface GmbH & Co. KG**  
 Klingenbergstraße 26  
 D-32758 Detmold  
 Germany

www.weidmueller.com

**Technical data**

Test for damage to and accidental loosening of conductors	Standard	DIN EN 60999-1 section 9.4 / 12.00	
	Requirement	0.2 kg	
	Conductor type	Type of conductor and conductor cross-section	AWG 24/1
		Type of conductor and conductor cross-section	AWG 24/19
	Evaluation	passed	
	Requirement	0.3 kg	
	Conductor type	Type of conductor and conductor cross-section	stranded 0.25 mm <sup>2</sup>
		Type of conductor and conductor cross-section	solid 0.5 mm <sup>2</sup>
	Evaluation	passed	
	Requirement	0.4 kg	
	Conductor type	Type of conductor and conductor cross-section	solid 1.5 mm <sup>2</sup>
		Type of conductor and conductor cross-section	stranded 1.5 mm <sup>2</sup>
Type of conductor and conductor cross-section		AWG 16/1	
Type of conductor and conductor cross-section		AWG 16/19	
Evaluation	passed		
Pull-out test	Requirement	≥10 N	
	Conductor type	Type of conductor and conductor cross-section	AWG 24/1
		Type of conductor and conductor cross-section	AWG 24/19
	Evaluation	passed	
	Requirement	≥20 N	
	Conductor type	Type of conductor and conductor cross-section	stranded 0.25 mm <sup>2</sup>
		Type of conductor and conductor cross-section	H05V-U0.5
	Evaluation	passed	
	Requirement	≥40 N	
	Conductor type	Type of conductor and conductor cross-section	H07V-U1.5
		Type of conductor and conductor cross-section	H07V-K1.5
		Type of conductor and conductor cross-section	AWG 16/1
Type of conductor and conductor cross-section		AWG 16/19	
Evaluation	passed		

## LSF-SMT 7.50/02/135 3.5SN BK TU

**Weidmüller Interface GmbH & Co. KG**  
 Klingenbergstraße 26  
 D-32758 Detmold  
 Germany

[www.weidmueller.com](http://www.weidmueller.com)

## Technical data

## Classifications

ETIM 6.0	EC002643	ETIM 7.0	EC002643
ETIM 8.0	EC002643	ETIM 9.0	EC002643
ECLASS 9.0	27-44-04-01	ECLASS 9.1	27-44-04-01
ECLASS 10.0	27-44-04-01	ECLASS 11.0	27-46-01-01
ECLASS 12.0	27-46-01-01	ECLASS 13.0	27460101

## Important note

IPC conformity Conformity: The products are developed, manufactured and delivered according international recognized standards and norms and comply with the assured properties in the data sheet resp. fulfill decorative properties in accordance with IPC-A-610 "Class 2". Further claims on the products can be evaluated on request.

## Notes

- Additional push button colours on request
- Operating force of slider max. 40 N
- Rated current related to rated cross-section & min. No. of poles.
- Wire end ferrule with plastic collar to DIN 46228/4
- Wire end ferrule without plastic collar to DIN 46228/1
- P on drawing = pitch
- Rated data refer only to the component itself. Clearance and creepage distances to other components are to be designed in accordance with the relevant application standards.
- Crimping shape "A" for wire end ferrules with PZ 6/5 crimping tool recommended.
- Long term storage of the product with average temperature of 50 °C and maximum humidity 70%, 36 months

## Approvals

## Approvals



ROHS	Conform
UL File Number Search	UL Website
Certificate No. (cURus)	E60693

## LSF-SMT 7.50/02/135 3.5SN BK TU

**Weidmüller Interface GmbH & Co. KG**  
Klingenbergstraße 26  
D-32758 Detmold  
Germany

[www.weidmueller.com](http://www.weidmueller.com)

# Technical data

## Downloads

Approval/Certificate/Document of Conformity	<a href="#">Declaration of the Manufacturer</a>
Engineering Data	<a href="#">CAD data – STEP</a>
Product Change Notification	<a href="#">Capacity expansion of LSF-SMT stamping tools</a> <a href="#">Kapazitätserweiterung der Stanzwerkzeuge LSF-SMT</a>
Catalogues	<a href="#">Catalogues in PDF-format</a>
Brochures	<a href="#">FL DRIVES EN</a> <a href="#">FL ANALO.SIGN.CONV. EN</a> <a href="#">MB SMT EN</a> <a href="#">FL DRIVES DE</a> <a href="#">MB DEVICE MANUF. EN</a> <a href="#">FL BUILDING SAFETY EN</a> <a href="#">FL APPL LED LIGHTING EN</a> <a href="#">FLIndustr.CONTROLS EN</a> <a href="#">FL MACHINE SAFETY EN</a> <a href="#">FL HEATING ELECTR EN</a> <a href="#">FL APPL INVERTER EN</a> <a href="#">FL_BASE_STATION_EN</a> <a href="#">FL ELEVATOR EN</a> <a href="#">FL POWER SUPPLY EN</a> <a href="#">FL 72H SAMPLE SER EN</a> <a href="#">PO OMNIMATE EN</a> <a href="#">PO OMNIMATE EN</a>
White paper surface mount technology	<a href="#">Download Whitepaper</a>

LSF-SMT 7.50/02/135 3.5SN BK TU

Weidmüller Interface GmbH & Co. KG  
 Klingenbergstraße 26  
 D-32758 Detmold  
 Germany

www.weidmueller.com

Drawings

Dimensional drawing

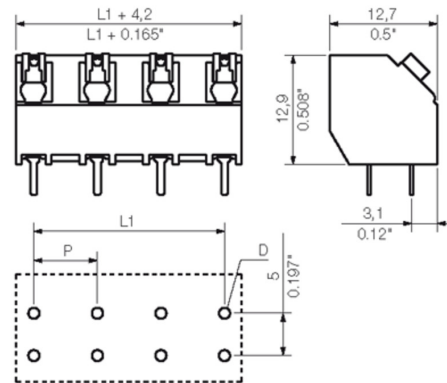

Graph

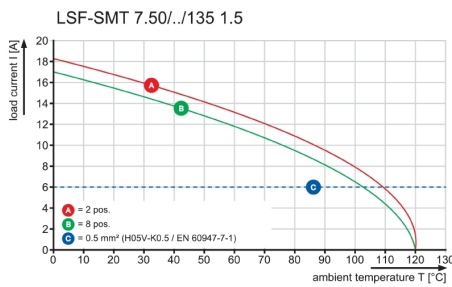

Graph

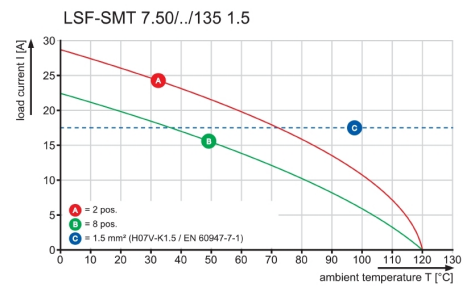

Graph

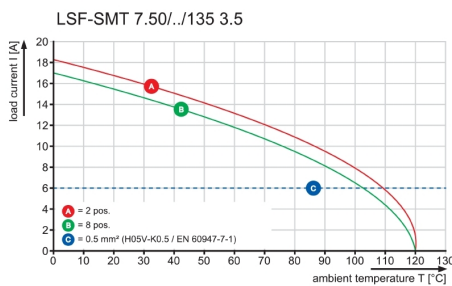

Graph

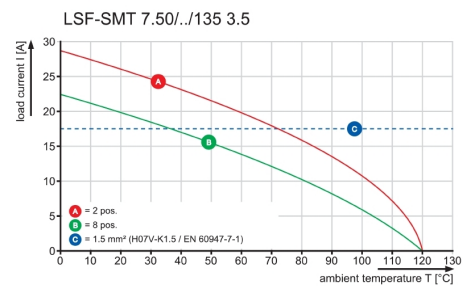



**LSF-SMT 7.50/02/135 3.5SN BK TU**

**Weidmüller Interface GmbH & Co. KG**  
 Klingenbergstraße 26  
 D-32758 Detmold  
 Germany

www.weidmueller.com

**Accessories**

**Slotted screwdriver**



Slotted screwdriver with rounded blade SD DIN 5265, ISO 2380/2, output to DIN 5264, ISO 2380/1. ChromTop tip, SoftFinish grip

**General ordering data**

Type	SDS 0.4X2.5X75	Version
Order No.	<a href="#">9009030000</a>	Screwdriver, Screwdriver
GTIN (EAN)	4032248266944	
Qty.	1 pc(s).	

**Slotted screwdriver**



VDE insulated slot-head screwdriver, SDI DIN 7437, ISO 2380/2, drive output acc. to DIN 5264, ISO 2380/1. SoftFinish grip

**General ordering data**

Type	SDIS 0.4X2.5X75	Version
Order No.	<a href="#">9008370000</a>	Screwdriver, Screwdriver
GTIN (EAN)	4032248056330	
Qty.	1 pc(s).	

## Recommended wave soldering profiles

**Weidmüller Interface GmbH & Co. KG**  
 Klängenbergstraße 16  
 D-32758 Detmold  
 Germany  
 Fon: +49 5231 14-0  
 Fax: +49 5231 14-292083  
 www.weidmueller.com

### Single Wave:



### Double Wave:



### Wave soldering profiles

Wired connection elements should be processed in accordance with the DIN EN 61760-1 standard. We have included two recommendations for practical wave soldering profiles, with which Weidmüller PCB terminals and connectors are qualified.

When choosing a suitable profile for your application, the following factors also need to be considered:

- PCB thickness
- Proportion of Cu in the layers
- Single/double-sided assembly
- Product range
- Heating and cooling rates

The single and double wave profiles each indicate the recommended operating range, including the maximum soldering temperature of 260°C. In practice, the maximum soldering temperature is quite often well below the above maximum profile.

## Recommended reflow soldering profile

**Weidmüller Interface GmbH & Co. KG**  
 Klingenbergstraße 16  
 D-32758 Detmold  
 Germany  
 Fon: +49 5231 14-0  
 Fax: +49 5231 14-292083  
 www.weidmueller.com



### Reflow soldering profile

The perfect soldering profile for SMT Surface Mount Technology is one the most exiting question in SMT production. But there are more than one correct answer: The diagram of temperature-on-time is related to processing features of solder paste and to maximum load of components.

We have to consider the following parameters:

- Time for pre heating
- Maximum temperature
- Time above melting point
- Time for cooling
- Maximum heating rate
- Maximum cooling rate

We recommend a typical solder profile with associated process limits. With preheating components and board are prepared smoothly for the solder phase. Heating rate is typically  $\leq +3\text{K/s}$ . In parallel the solder paste is ‚activated‘. The time above melting point of 217°C the paste gets liquid and components and boards begin to connect. The maximum temperature of 245°C to 254°C should stay between 10 and 40 seconds. In the cooling phase at  $\geq -6\text{K/s}$  solder is cured. Board and components cool down while avoiding cold cracks.